

ハロゲンランプ

HALOGEN LAMP

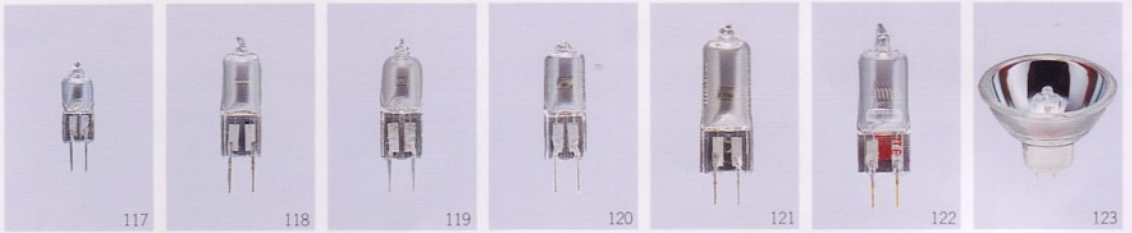

ランプ TYPE	電圧 V	電力 W	バルブ径 φ	全長 M.O.L. mm	光中心距離 L.C.L. mm	フィラメント		口金 BASE	全光束 Lumens	色温度 K	平均寿命 Life (hrs)	参照		Figure No	Picture No
						形状	寸法 mm 横 × 縦					Philips	ANSI		
JC 6V10W	6	10	9	30	19.5	C-6	1.7×0.6	G4	200	3200	100	7387	ESA/FHD	A	117
JC 6V10W 20H	6	10	9	30	19.5	C-6	2.1×0.8	G4	120	3000	2000			A	117
JC 6V20W	6	20	9	31	19.5	C-6	2.0×1.0	G4	475	3200	100	7388	ESB	A	117
JC 6V20W 20H	6	20	9	30	19.5	C-6	3.2×0.94	G4	320	3000	2000			A	117
JC 6V30W G4	6	30	9	31	19.5	CBAR6	1.7×1.7	G4	760	3200	100	5761		A	
JC 6V30W G6.35	6	30	11.5	44	28	CBAR6	1.8×1.8	G6.35	690	3200	100			A	
JC 12V10W 20H	12	10	9	31	19.5	C-2R	—	G4	140	2900	2000			A	
JC 12V20W 20H	12	20	9	30	19.5	C-6	3.5×0.86	G4	350	2900	2000			A	
JC 12V30W 10H	12	30	9	44	30	C-6	3.4×0.97	G6.35	600	3000	1000			A	118
JC 12V30W 20H	12	30	9	44	30	C-6	4.1×0.97	G6.35	480	2900	2000			A	118
JC 12V35W 20H	12	35	11.5	44	30	C-6	4.0×1.46	G6.35	630	3000	2000			A	
JC 12V50W	12	50	11.5	44	30	CBAR6	3.3×1.6	G6.35	1500	3300	50	7027	BRL/BCD	A	119
JC 12V50W 20H	12	50	11.5	44	30	CBAR6	5.4×2.0	G6.35	850	3000	2000			A	119
JC 12V100W	12	100	11.5	44	30	CBAR6	4.2×2.3	GY6.35	3400	3400	50	7023	FGR	A	120
JC 12V100W 20H	12	100	11.5	44	30	CBAR6	4.8×3.0	GY6.35	2550	3200	2000	7724	EVA	A	120
JC 15V150W	15	150	11.5	44	30	CBAR6	4.8×3.0	G6.35	5000	3400	50	6550	EVB/BJR	A	
JC 24V100W 20H	24	100	11.5	44	30	C-6	5.5×3.0	G6.35	2000	3000	2000			A	
JC 24V150W	24	150	13.5	50	32	CBAR6	5.8×2.9	G6.35	5200	3400	50	7158	FCS	A	121
JC 24V300W	24	300	13.5	55	33	CBAR6	6.7×4.6	G6.35	9900	3400	050			A	121
JCD 22.8V 40W	22.8	40	11.5	44	30	CC-6	4.5×1.5	G6.35	850	3050	700			A	
JC 22.8V 50W	22.8	50	11.5	44	30	CBAR6	4.8×2.0	G6.35	1100	3050	700			A	38
JCD 24V 35W	24	35	10.5	40	22.7	CC-6	4.0×1.8	G6.35	700	3100	700			A	
JCD 100V150W	100	150	13.5	50	32	CC-6	8.1×2.8	G6.35	3300	3075	200		ESY	A	122

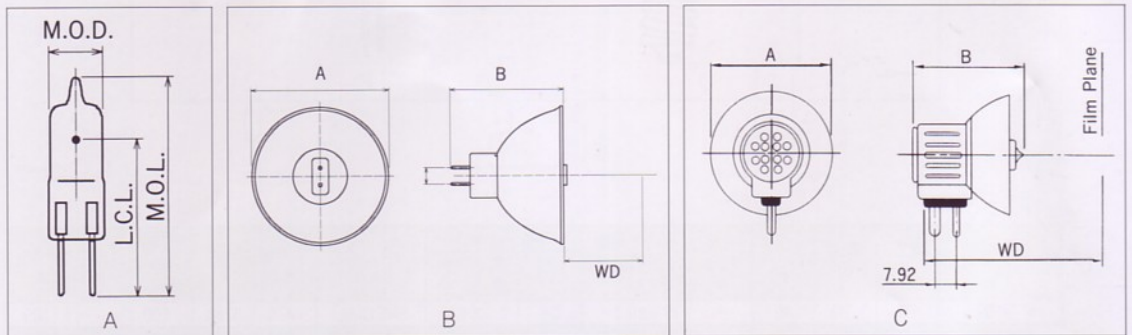

ランプ TYPE	電圧 V	電力 W	寸法 mm		焦点距離 WD mm	フィラメント 形状	口金 BASE	色温度 K	平均寿命 Life (hrs)	参照		Figure No	Picture No
			直 径 A	全 長 B						Philips	ANSI		
JCR 6V 15W	6	15	35	40	108	C-6	GZ4	—	500	13528		B	
JCR 15V 150W	15	150	50	42	32	C-8	GZ6.35	3350	50	6423	EFR	B	123
JCR 12V 50W20H	12	50	50	42	32	C-8	GZ6.35	3050	2000			B	123
JCR 12V 100W10H	12	100	50	42	36	C-8	GZ6.35	3100	1000			B	123
DNF21V 150W	21	150	57.15	45.1	69.1	CC-6	GX7.9	3400	25		DNF	C	

ハロゲンランプ ハロゲンランプ用ソケット

HALOGEN LAMP SOCKET



124



125

ランプ No.	電圧 V	電流 (A)	バルブ径 φ	全長 M.O.L mm	フィラメント 形状 Filament Type	全光束 Lumens	色温度 K	平均寿命 Life (hrs)	Picture No.
HG-9400	2.5	(0.680)	T-4.8	13	C-6	18	3020	20	124
HG-9401	3.5	(0.715)	T-4.8	13	C-6	36	3050	25	124
HG-9402	3.5	(0.740)	TL-3.9	12	C-6	34	3030	50	125
HG-9403	2.5	(0.680)	TL-4.8	13	C-6	18	3020	20	125
HG-9404	3.5	(0.715)	TL-4.8	13	C-6	36	3050	25	125



126

990

適合口金：G4 GZ4
50V 10A
セラミック
シリコン電線 180°C
0.75mm²×135mm

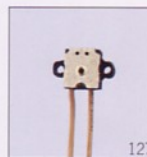
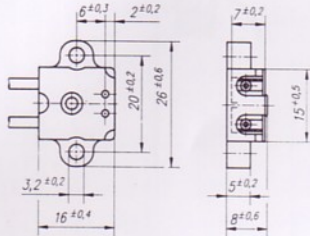

127

992

適合口金：G4 GZ4
50V 10A
耐熱合成樹脂
シリコン電線 180°C
0.75mm²×135mm

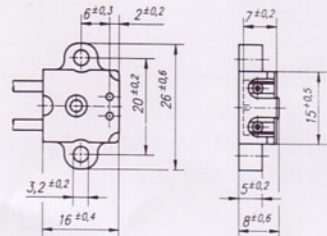

128

993

適合口金：G4
50V 2A
セラミック
シリコン電線 180°C
0.75mm²×145mm

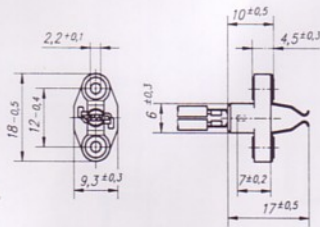

129

994

適合口金：G4 GZ4
50V 10A
セラミック
シリコン電線 180°C
0.75mm²×140mm

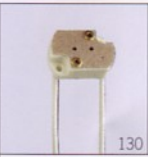
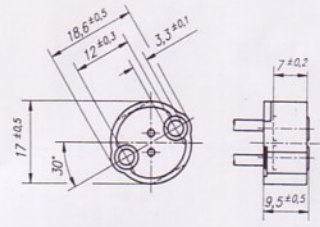

130

HS-60T

適合口金：G6.35 GZ6.35
50V 10A
セラミック
シリコン電線 180°C
0.75mm²×200mm

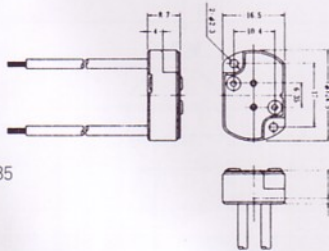

131

**HS-14-1
HS-14-1.25**

適合口金：G6.35 GY6.35
50V 10A
セラミック
シリコン電線 180°C
1.25mm²×200mm

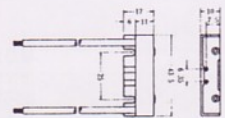

132

LH-100

適合：φ50
(基準実起付ミラー)

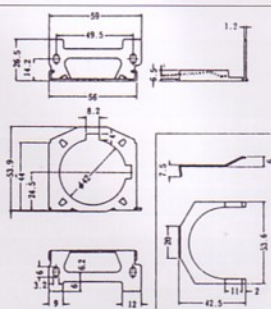

LH-500/500B

適合：φ50.8/φ50

