

# gF, gl-gG, aM

## CYLINDRICAL FUSE-LINKS



### DOMESTIC AND INDUSTRIAL CYLINDRICAL FUSE-LINKS

Ferraz Shawmut gF, gl-gG and aM fuse-links cover a wide range of physical sizes and ampere ratings for 250, 400, 500, and 690 volts AC. gF fuse-links are for domestic use. gl-gG and aM fuse-links are for industrial applications. Most ratings are available with an optional indicator. All industrial fuse-links have the option of a built-in striker. All cylindrical fuse-links have ceramic bodies and silver-plated ferrules.

### gF

#### FULL RANGE PROTECTION

- 7 physical sizes from 6.3 x 23mm to 10.3 x 38 mm
- 250 and 400 Volt ratings - 0.5A through 32A
- Most ratings available with indicator
- Meet IEC, NFC, UNE and British standards

### gl-gG

#### FULL RANGE PROTECTION

- 4 physical sizes from 8 x 31mm to 22 x 58 mm
- 400, 500 and 690 Volt ratings - 0.5A through 125A
- Most ratings available with indicator
- Meet IEC, NFC and UNE standards
- Approved by Lloyds Register of Shipping and Bureau Veritas

### gl-gG

#### FULL RANGE PROTECTION

##### Fuse-links with Striker

- 2 sizes - 14 x 51mm and 22 x 58mm
- 400, 500 and 690 Volt ratings - 4A through 125A
- All ratings include striker
- Meet IEC, NFC and UNE standards
- Approved by Lloyds Register of Shipping and Bureau Veritas

### aM

#### SHORT CIRCUIT PROTECTION

- 4 physical sizes from 8 x 31mm to 22 x 58mm
- 400, 500 and 690 Volt ratings - .16A through 125A
- Most ratings available with indicator
- Meet IEC, NFC and UNE standards
- Approved by Lloyds Register of Shipping and Bureau Veritas

### aM

#### SHORT CIRCUIT PROTECTION

##### Fuse-links with Striker

- 2 sizes - 14 x 51mm and 22 x 58mm
- 400, 500 and 690 Volt ratings - 2A through 125A
- All ratings include striker
- Meet IEC, NFC and UNE standards
- Approved by Lloyds Register of Shipping and Bureau Veritas

Catalog Numbers, Ratings – gF (Optional Blown-Fuse Indicator)



SIZE (mm x mm)	RATED In CURRENT (A)	RATED VOLTAGE	CATALOG NUMBER		INTERRUPTING RATING (A)	STANDARD PACK/CTN.
			w/o Indicator	w/Indicator		
6.3 x 23	2	250V	10013-G	-	6,000	10/100
	4		10019-G	-		
	6		10023-G	-		
	10		10031-G	-		
8.5 X 23	2	250V	10213-G	12213-G	6,000	10/100
	4		10219-G	12219-G		
	6		10223-G	12223-G		
	10		10231-G	12231-G		
	16		10235-G	12235-G		
10.3 X 25.8	6	250V	10423-G	12423-G	6,000	10/100
	10		10431-G	12431-G		
	16		10435-G	12435-G		
8.5 x 31.5	0.5	400V	10609-G	12609-G	20,000	10/100
	1		10611-G	12611-G		
	2		10613-G	12613-G		
	4		10619-G	12619-G		
	6		10623-G	12623-G		
	8		10627-G	12627-G		
	10		10631-G	12631-G		
	12		10633-G	12633-G		
	16		10635-G	12635-G		
	20		10637-G	12637-G		
	25		10639-G	12639-G		
10.3 x 31.5	16	400V	10835-G	12835-G	20,000	10/100
	20		10837-G	12837-G		
	25		10839-G	12839-G		
8.5 x 36	2	400V	11013-G	13013-G	20,000	10/100
	4		11019-G	13019-G		
	6		11023-G	13023-G		
	10		11031-G	13031-G		
	16		11035-G	13035-G		
	20		11037-G	13037-G		
	25		11039-G	13039-G		
	32		11043-G	13043-G		
10.3 x 38	25	400V	11239-G	13239-G	20,000	10/100
	32		11243-G	13243-G		



- 1 Ceramic body
- 2 Sand
- 3 Indicator contact
- 4 Lower contact
- 5 Contact ring
- 6 Melting element
- 7 Indicator

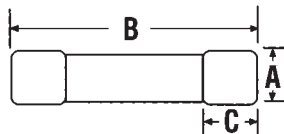
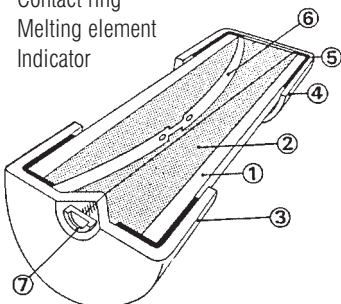

Dimensions

FUSE SIZE (mm x mm)	A	B	C
6.3 X 23	6.3	23	5
8.5 X 23	8.5	23	5
10.3 x 25.8	10.3	25.8	6.3
8.5 x 31.5	8.5	31.5	6.3
10.3 x 31.5	10.3	31.5	10
8.5 x 36	8.5	36	6.3
10.3 x 38	10.3	38	10

Blown-Fuse Indicator

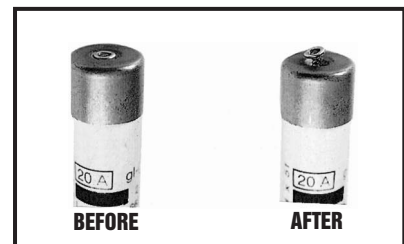

**gF**

**CYLINDRICAL FUSE-LINKS**

**Melting Time - Current Data – 2-16 Amperes, 250V**

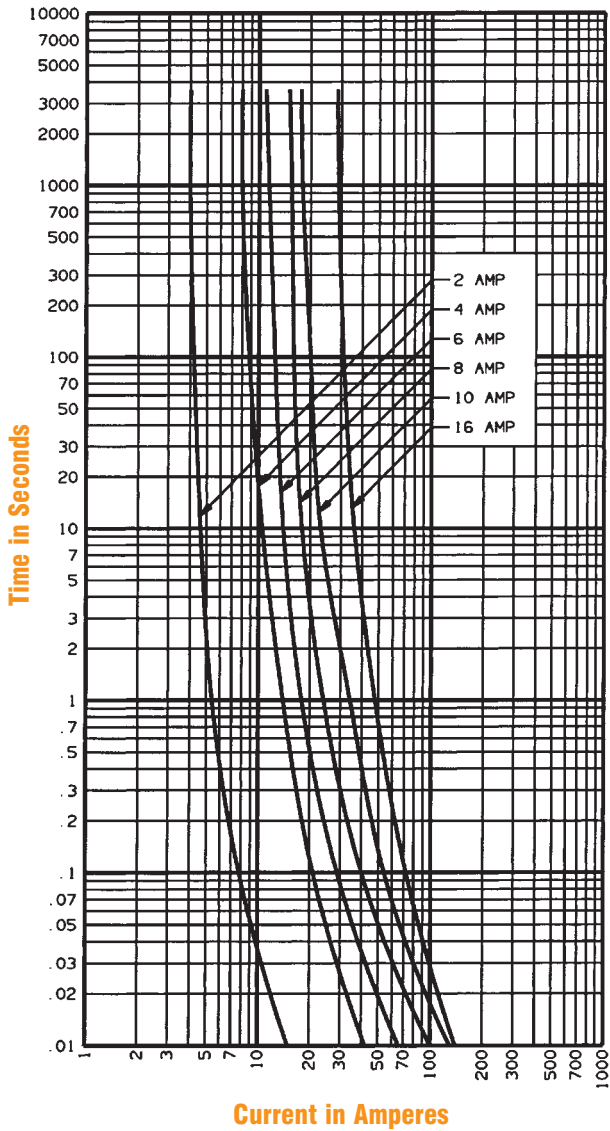

**Melting Time - Current Data – 2-32 Amperes, 400V**

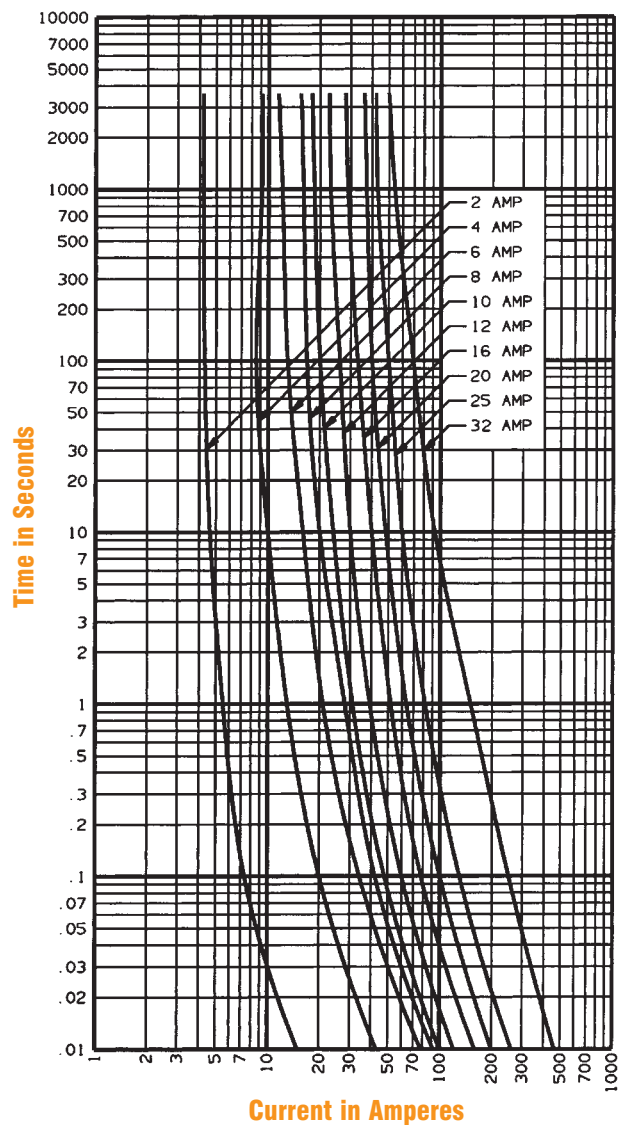

# gl-gG

## CYLINDRICAL FUSE-LINKS

### Catalog Numbers, Ratings – gl-gG (Optional Blown-Fuse Indicator)



SIZE (mm x mm)	RATED In CURRENT (A)	RATED VOLTAGE	CATALOG NUMBER		INTERRUPTING RATING (A)	STANDARD PACK/CTN.	
			w/o Indicator	w/Indicator			
8 x 31	0.5	400V	15009-G	-	20,000	10/100	
	1		15011-G	15211-G			
	2		15013-G	15213-G			
	4		15019-G	15219-G			
	6		15023-G	15223-G			
	8		15027-G	15227-G			
	10		15031-G	15231-G			
	12		15033-G	15233-G			
	16		15035-G	15235-G			
	20		15037-G	15237-G			
	10 X 38		0.5	500V			16009-G
1		16011-G	-				
2		16013-G	16213-G				
4		16019-G	16219-G				
6		16023-G	16223-G				
8		16027-G	16227-G				
10		16031-G	16231-G				
12		16033-G	16233-G				
16		16035-G	16235-G				
20		16037-G	16237-G				
14 X 51		1	690V		17011-G	-	80,000
	2	17013-G		17213-G			
	4	17019-G		17219-G			
	6	17023-G		17223-G			
	8	17027-G		17227-G			
	10	17031-G		17231-G			
	12	17033-G		17233-G			
	16	17035-G		17235-G			
	20	17037-G		17237-G			
	25	17039-G		17239-G			
	32	17043-G		17243-G			
40	500V	17047-G	17247-G				
		50	17051-G	17251-G			
		400V	18013-G	-	80,000	10/50	
			4	18019-G			18219-G
			6	18023-G			18223-G
8	18027-G		18227-G				
10	18031-G		18231-G				
12	18033-G	18233-G					
16	18035-G	18235-G					
20	18037-G	18237-G					
25	18039-G	18239-G					
32	18043-G	18243-G					
40	18047-G	18247-G					
50	18051-G	18251-G					
63	18055-G	18255-G					
80	18059-G	18259-G					
100	18063-G	18263-G					
125	18065-G	18265-G					



### Blown-Fuse Indicator

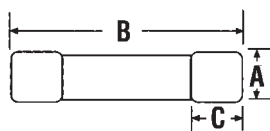
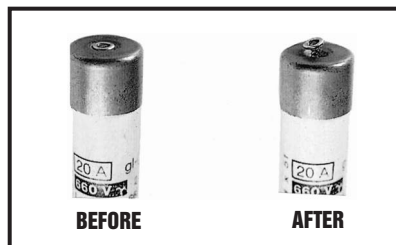

### Dimensions

FUSE SIZE	A	B	C
8 x 31	8.5	31.5	6.3
10 x 38	10.3	38	10.5
14 x 51	14.3	51	13.8
22 x 58	22.2	58	16.2

# gl-gG

## CYLINDRICAL FUSE-LINKS



17447-G



18447-G

### Striker

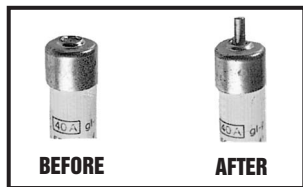

- 1 Ceramic body
- 2 Sand
- 3 Indicator contact
- 4 Lower contact
- 5 Contact ring
- 6 Melting element
- 7 Indicator

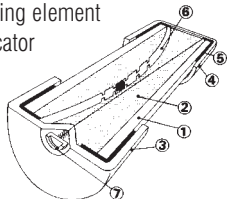

### Catalog Numbers, Ratings – gl-gG with Striker

SIZE (mm x mm)	RATED CURRENT In (A)	RATED VOLTAGE	CATALOG NUMBER	INTERRUPTING RATING (A)	STANDARD PACK/CTN.				
14 X 51	2	500V	17413-G	120,000	10/50				
	4		17419-G						
	6		17423-G						
	8		17427-G						
	10		17431-G						
	12		17433-G						
	16		17435-G						
	20		17437-G						
	25		17439-G						
	32		17443-G						
	40		17447-G						
	50		17451-G						
	22 X 58		4			690V	18419-G	80,000	10/50
6		18423-G							
8		18427-G							
10		18431-G							
12		18433-G							
16		18435-G							
22 X 58		20	500V	18437-G	120,000				
		25		18439-G					
		32		18443-G					
		40		18447-G					
		50		18451-G					
		63		18455-G					
		80		18459-G					
		100		18463-G					
		125		18465-G					
		22 X 58		40		400V	18451-G	120,000	
				63			18455-G		
				80			18459-G		

### Dimensions

FUSE SIZE	A	B	C	D	E
14 x 51	14.3	51	13.8	7.5	3.8
22 x 58	22.2	58	16.2	7.5	3.8

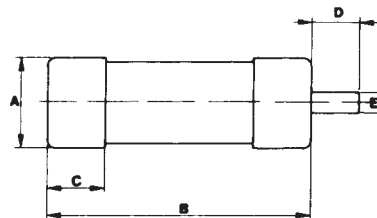

### Melting Time - Current Data – 2-125 Amperes

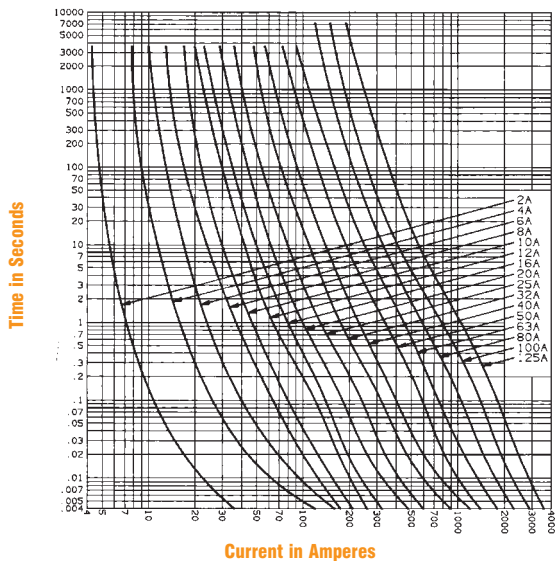

### Peak Let-Thru Current Data – 2-125 Amperes

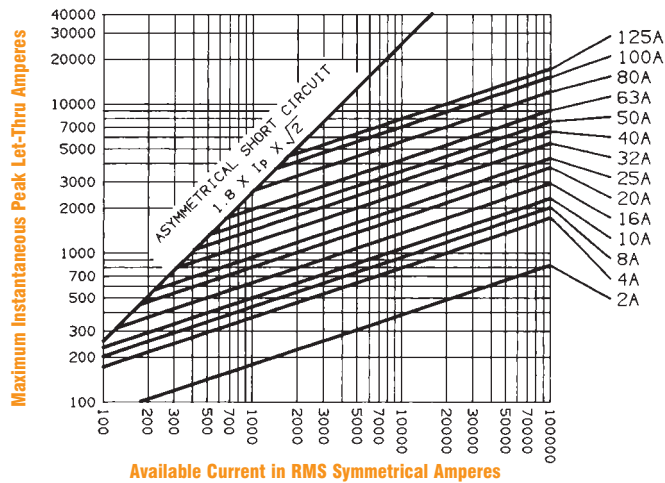

# gl-gG

## CYLINDRICAL FUSE-LINKS

**$I^2t$  Characteristics – Discrimination**

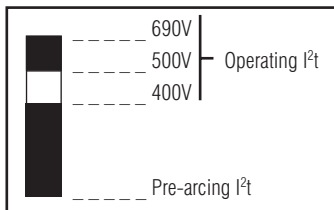
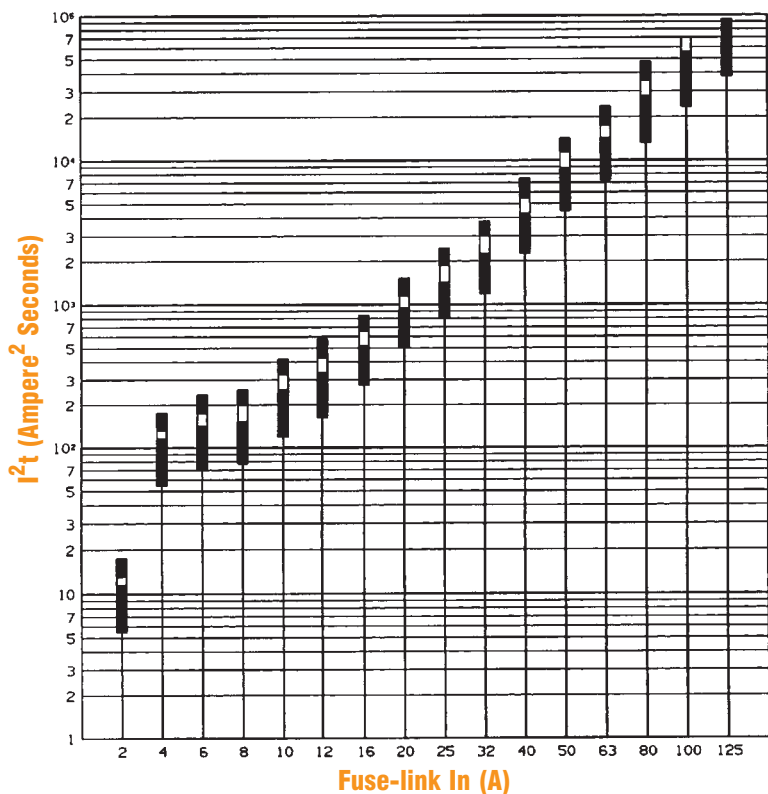

**Power Loss (Watts) at Rated Current In**

RATED CURRENT (A)	SIZE		
	10 x 38	14 x 51	22 x 58
1	0.27 W		
2	0.4 W	0.5 W	
4	0.60 W	0.7 W	0.9 W
6	0.85 W	1.0 W	1.3 W
8	1.0 W	1.3 W	1.45 W
10	1.2 W	1.5 W	1.85 W
12	1.4 W	1.7 W	2.2 W
16	1.6 W	2.0 W	2.3 W
20	1.9 W	2.3 W	2.65 W
25	2.3 W	2.7 W	3.1 W
32	2.9 W	3.3 W	3.85 W
40		4 W	4.8 W
50		4.5 W	5.3 W
63			6.5 W
80			8 W
100			9 W
125			12.5 W

IEC 269-2	10 x 38	14 x 51	22 x 58
NFC 63210	25A	40A	100A
UBE 21103	3 W	5W	9.5 W

These values are much lower than those allowed by the standards.



### Temperature

Temperature rise reached by gl-gG fuse-links at  $I_n$ , measured on their upper contact.

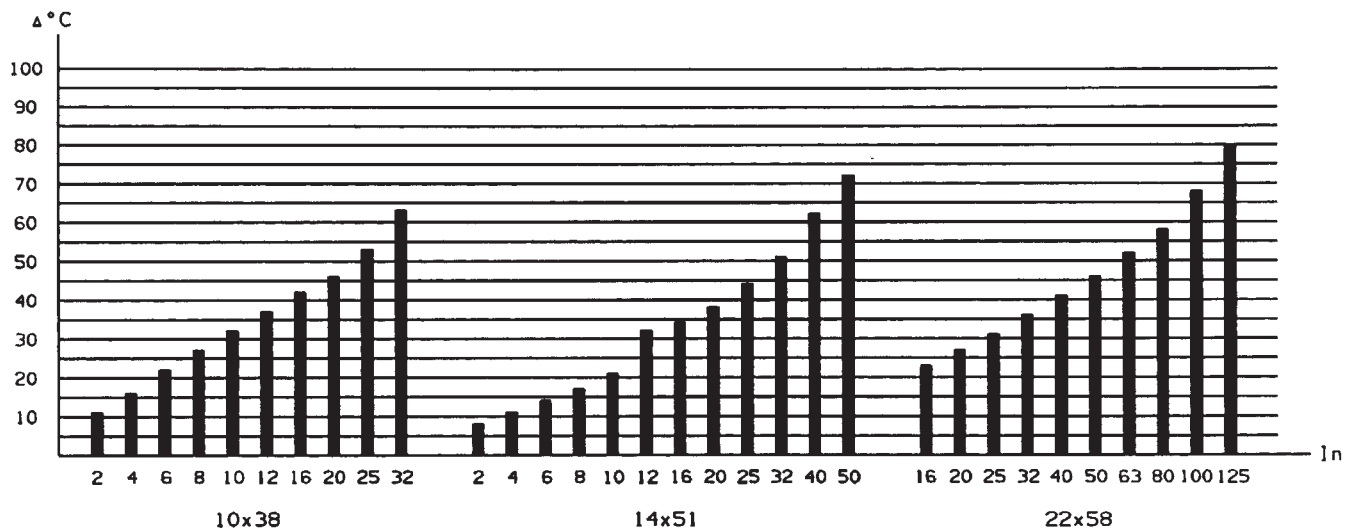

# aM

## CYLINDRICAL FUSE-LINKS

### Catalog Numbers, Ratings – aM (Optional Blown-Fuse Indicator)



SIZE (mm x mm)	RATED In CURRENT (A)	RATED VOLTAGE	CATALOG NUMBER		INTERRUPTING RATING (A)	STANDARD PACK/CTN.
			w/o Indicator	w/Indicator		
8 x 31	1	400V	15511-G	-	20,000	10/100
	2		15513-G	-		
	4		15519-G	-		
	6		15523-G	-		
	8		15527-G	-		
	10		15531-G	-		
10 X 38	0.16	500V	16503-G	-	120,000	10/100
	0.25		16507-G	-		
	0.5		16509-G	-		
	1	16511-G	16711-G			
	2	16513-G	16713-G			
	4	16519-G	16719-G			
	6	16523-G	16723-G			
	8	16527-G	16727-G			
	10	16531-G	16731-G			
	12	16533-G	16733-G			
	16	16535-G	16735-G			
	20	16537-G	16737-G			
	25	16539-G	16739-G			
	14 X 51	0.25	690V	17507-G		
0.5		17509-G		-		
1		17511-G		17711-G		
2		17513-G		17713-G		
4		17519-G		17719-G		
6		17523-G		17723-G		
8		17527-G		17727-G		
10		17531-G		17731-G		
12		17533-G		17733-G		
16		17535-G		17735-G		
20		17537-G		17737-G		
25		17539-G		17739-G		
32		17543-G		17743-G		
40		17547-G	17747-G			
45	17549-G	17749-G				
50	17551-G	17751-G				
22 x 58	4	690V	18519-G	18719-G	80,000	10/50
	6		18523-G	18723-G		
	8		18527-G	18727-G		
	10		18531-G	18731-G		
	12		18533-G	18733-G		
	16		18535-G	18735-G		
	20		18537-G	18737-G		
	25		18539-G	18739-G		
	32		18543-G	18743-G		
	40		18547-G	18747-G		
	50		18551-G	18751-G		
	63		18555-G	18755-G		
	80		18559-G	18759-G		
	100	18563-G	18763-G			
125	18565-G	18765-G				
	500V	400V			120,000	
	400V					

### Blown-Fuse Indicator

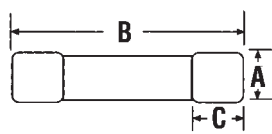
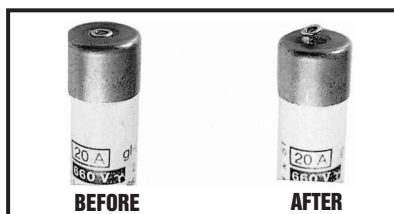

### Dimensions

FUSE SIZE	A	B	C
8 x 31	8.5	31.5	6.3
10 x 38	10.3	38	10.5
14 x 51	14.3	51	13.8
22 x 58	22.2	58	16.2

# aM

## CYLINDRICAL FUSE-LINKS

### Catalog Numbers, Ratings – aM with Striker

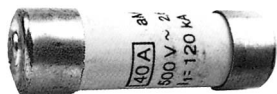

17947-G



18951-G

#### Striker

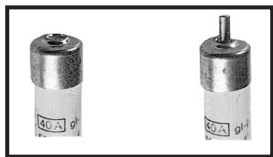

BEFORE

AFTER

SIZE (mm x mm)	RATED In CURRENT (A)	RATED VOLTAGE	CATALOG NUMBER	INTERRUPTING RATING (A)	STANDARD PACK/CTN.
14 X 51	1	500V	17911-G	120,000	10/50
	2		17913-G		
	4		17919-G		
	6		17923-G		
	8		17927-G		
	10		17931-G		
	12		17933-G		
	16		17935-G		
	20		17937-G		
	25		17939-G		
	32		17943-G		
	40		17947-G		
	45		17949-G		
	50		17951-G		
	22 X 58		4		
6		18923-G			
8		18927-G			
10		18931-G			
12		18933-G			
16		18935-G			
20		18937-G			
25		18939-G			
32		18943-G			
40		18947-G			
50		18951-G			
63		18955-G			
80		18959-G			
100		18963-G			
125		18965-G			
		500V 400V		120,000	



#### Dimensions

FUSE SIZE	A	B	C	D	E
14 x 51	14.3	51	13.8	7.5	3.8
22 x 58	22.2	58	16.2	7.5	3.8

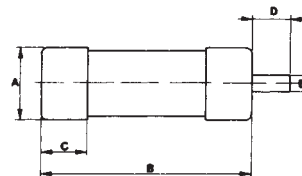

Melting Time - Current Data – 1-125 Amperes

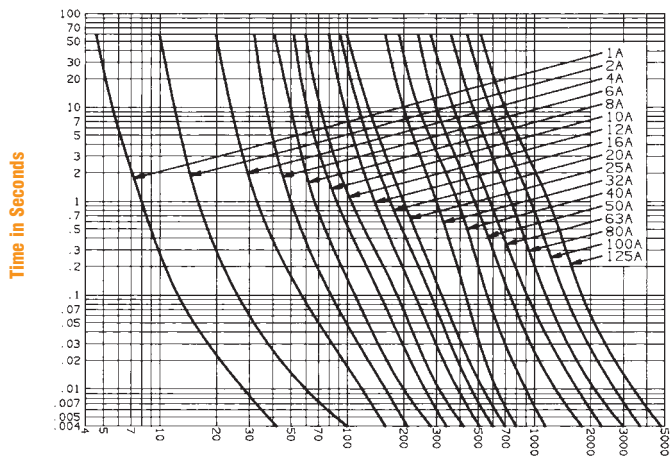

Current in Amperes

Peak Let-Thru Current Data – 1-125 Amperes

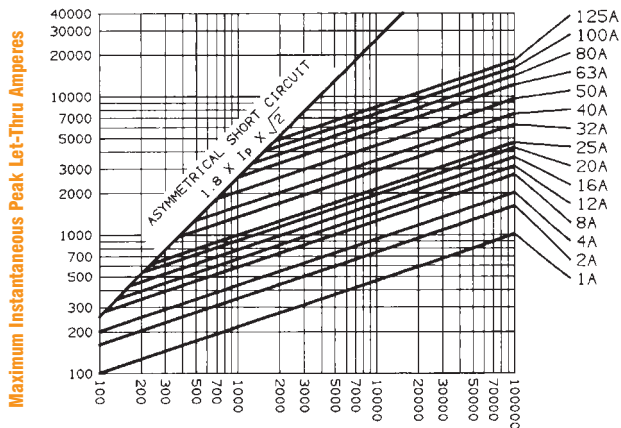

Available Current in RMS Symmetrical Amperes



# aM

## CYLINDRICAL FUSE-LINKS

### I<sup>2</sup>t Characteristics – Discrimination

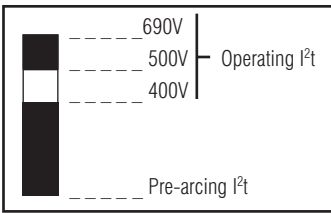
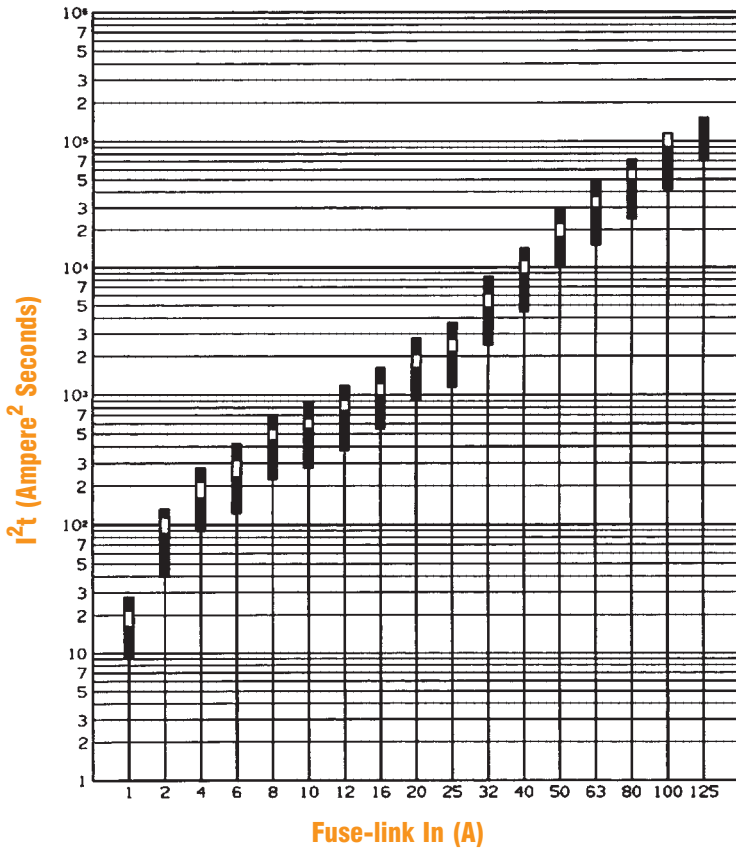

### Power Loss (Watts) at Rated Current In

RATED In CURRENT (A)	SIZE		
	10 x 38	14 x 51	22 x 58
1	0.1 W		
2	0.2 W	0.3 W	
4	0.3 W	0.4 W	0.5 W
6	0.4 W	0.5 W	0.6 W
8	0.5 W	0.6 W	0.8 W
10	0.6 W	0.8 W	1.0 W
12	0.7 W	1.0 W	1.2 W
16	0.8 W	1.2 W	1.5 W
20	1.2 W	1.5 W	1.8 W
25	1.6 W	1.9 W	2.0 W
32	2.0 W	2.3 W	2.6 W
40		2.6 W	3.2 W
50		2.9 W	3.9 W
63			4.7 W
80			5.9 W
100			6.5 W
125			9.5 W

IEC 269-2	10 x 38	14 x 51	22 x 58
NFC 63210	16 A	50 A	100 A
UNE 21103	1.2 W	3 W	7 W

These values are much lower than those allowed by the standards.

### Temperature

Temperature rise reached by aM fuse-links at In, measured on their upper contact.

