

Brake Pack for Standard AC Motors SB50

Additional Information

- Technical Reference.....F-1
- General Information.....G-1

Introduction

Induction Motors

Reversible Motors

Synchronous Motors

Torque Motors

Waterlight Motors

Magnetic Brake

Clutch & Brake

Brake Pack

Right-Angle Gearheads

Accessories

Before Using a Standard AC Motor

Brake Pack for Standard AC Motors

SB50

The **SB50** provides instantaneous stop, forward/reverse operation, electromagnetic brake control and thermal-protector open-detection functions integrated into one unit. These brake packs can sense when the thermal protector is opened, further ensuring the safety of your equipment. The **SB50** can be used with induction motors, reversible motors, watertight motors and electromagnetic brake motors.

Features

Four Functions in One Integrated Unit

The **SB50** provides instantaneous stop, forward/reverse operation, electromagnetic brake control and thermal protector open detection functions.

* Thermal protector open detection function

When the motor's thermal protector (overheat protection device) is activated, the **SB50** outputs an alarm signal and automatically cuts the power supply to the motor. The motor will not restart by itself, even when the temperature drops and the thermal protector recovers, until the power is cycled. (Available only when combined with a motor having a built-in thermal protector).

Instantaneous Stop

The electronic brake stops the motor instantly. A large braking force causes the motor to stop in approximately 0.1 seconds, allowing for an overrun of 0.5 to 1.0 revolutions. The braking current flows through the motor for approximately 0.4 seconds, after which the power supply to the motor is cut off automatically (the motor will lose its holding brake force).

Long Life, Simple Wiring and Maintenance-Free

The electronic brake operates on current flow, so it lasts longer than the mechanically operated electromagnetic brake that is subject to wear. This makes the **SB50** ideal for indexing applications. The Electronic type input brake pack doesn't use a power relay, so no maintenance is required. Wiring is easy, as well.

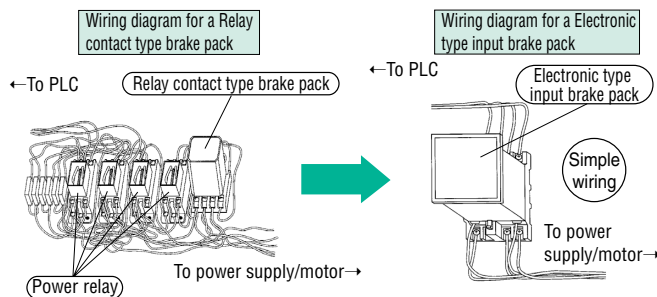

Wide Voltage Range of 100 to 230 VAC

The **SB50** covers a single-phase voltage range of 100 to 230 VAC $\pm 10\%$, 50/60 Hz, accommodating all of the world's key voltage specifications.

Supports Motors with 1W to 90W Output

The **SB50** can be used with induction, reversible, electromagnetic brake and dust-resistant, watertight motors with an output range of 1W to 90W.

Brake Pack with an Electromagnetic Brake Motor

By combining the **SB50** with a motor equipped with an electromagnetic brake, you can link the electronic brake with the electromagnetic brake to allow the load to be held automatically following an instantaneous stop. This configuration is ideal for vertical applications in which the load must be held following the instantaneous stopping of the motor.

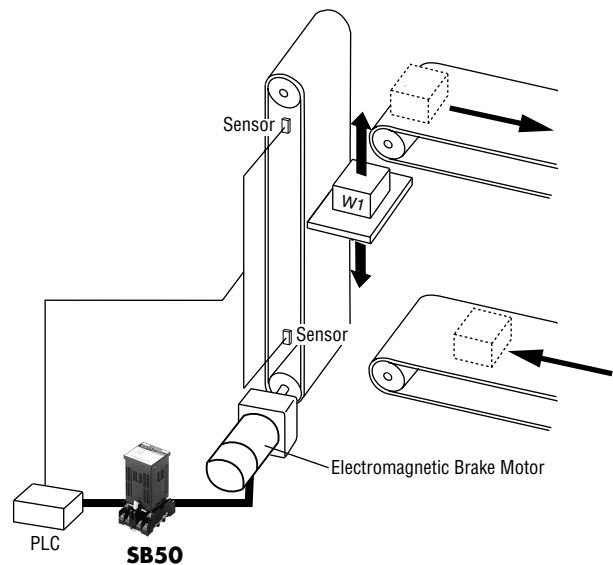

Characteristics of Brake Pack

How to Read Braking Characteristics (reference values)

The brake pack provides stable braking characteristics for the instantaneous stopping of the motor. The braking characteristics are illustrated by the braking curve, which indicates the amount of shaft overrun corresponding to the load inertia. The braking time is $[4n/f]$ seconds or less (where n: overrun, f: power supply frequency).

For example, if the **4IK25GN-AWU** (single-phase 115 VAC, 25 W) and **SB50** are used together to stop a load with an inertia of $J = 1.37 \text{ oz-in}^2$ ($0.25 \times 10^{-4} \text{ kg-m}^2$), the overrun and braking time required will be approximately 1.4 revolutions and 0.1 second, respectively, at a power-supply frequency of 60 Hz. In the case of deceleration using a gearhead, see the braking characteristics curve after converting the load inertia at the gearhead shaft to its corresponding value at the motor shaft.

Use the following formula to convert the load inertia at the gearhead shaft to its corresponding value at the motor shaft:

$$J_M = \frac{J_G}{i^2} [\text{oz-in}^2]$$

J_M : Load inertia converted to corresponding value at motor shaft

J_G : Load inertia at gearhead shaft

i : Gear ratio of gearhead

Stopping Accuracy

The figure to the right shows the stopping position error (variation in stopping position) when braking force is applied to the motor using the brake pack. The diagram shows an overrun distribution when braking is repeated 500 times under the same conditions. Varying stopping positions are caused by the power-supply phase when the switch is operated to apply the brake, which could generate a maximum delay of one cycle (power supply frequency) and variation in initial braking force. The sagging at the center reflects the slot-position relationship between the stator and rotor. Refer to the braking characteristics curve representing the average overrun.

Example of Braking Characteristics with Brake Pack

Brake Pack: **SB50**

Motor: **4IK25GN-AWU**

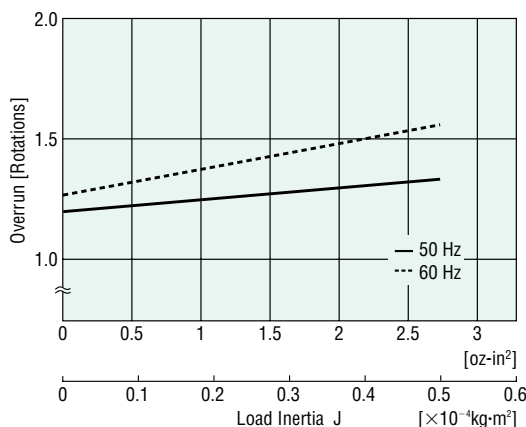

Brake Pack: **SB50**

Motor: **4IK25GN-AWU**

$J: 1.37 \text{ oz-in}^2$ ($0.25 \times 10^{-4} \text{ kg-m}^2$)

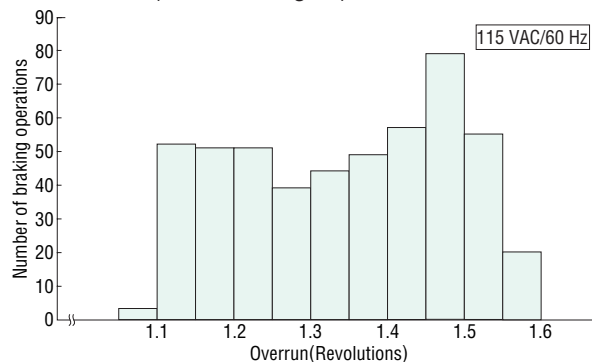

Other Brake Motors

In addition to the brake pack, various brake motors are available to suit a variety of applications.

How to Select a Brake Motor

Selecting based on stopping accuracy

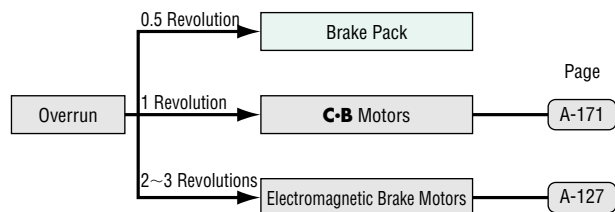

* The overrun values are those of an individual motor.

Selecting based on frequency of use

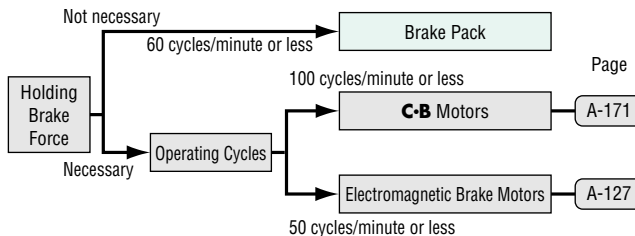

Notes:

- The operating cycles are based merely on brake response. The value specified above is the maximum, so it may not be possible to repeat braking operation at this frequency.
- In an actual application, be certain the surface temperature of the motor case remains below 194°F (90°C) by considering a rise in motor temperature.

System Configuration

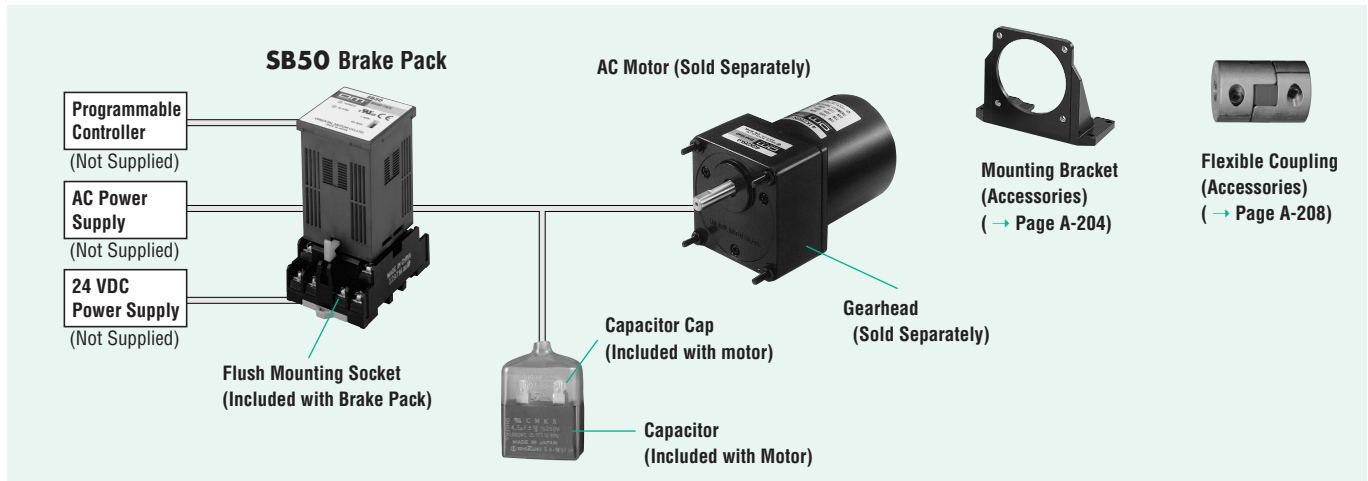

The system configuration shown is an example. Other combinations are available.

Specifications



Model	Power Source	Frequency	Applicable Motor Output	Functions	Power Source for Control	Input Signals	Output Signals	Braking Current Duration
SB50	Single-Phase 100-230 VAC ±10%	50/60 Hz	1/750 HP~1/8 HP 1 W~90 W	Instantaneous stop, Clockwise and counterclockwise rotation, Electromagnetic brake release (Electromagnetic brake motors) Thermal-protector open detection (Alarm output)	24 VDC±10% 0.1 A min.	CW, CCW, FREE Input specifications Photocoupler input Input impedance: 4.7 kΩ; 24 VDC±10%	ALARM Output specifications Open Collector Output External usage conditions 26.4 VDC max., 10 mA max.	approximately 0.2~0.4 seconds

General Specifications

Item	Specifications
Insulation Resistance	100 MΩ or more when measured by a 500 VDC megger between the input terminal and the output signal terminal after rated motor operation under normal ambient temperature and humidity.
Dielectric Strength	Sufficient to withstand 3.0 kV at 60 Hz applied between the input terminal and the output signal terminal for 1 minute after rated motor operation under normal ambient temperature and humidity.
Ambient Temperature	32°F~104°F (0°C~+40°C) (nonfreezing)
Ambient Humidity	85% max. (noncondensing)
Degree of Protection	IP10

Safety Standard and CE Marking

Applicable Standards	Certification Body	Standards File No.	CE Marking
UL508 CSA C22.2 No.14 EN50178 EN60950	UL Conform to EN standards	E91291	Low Voltage Directives EMC Directives

- **Details of Safety Standards** →Page G-2
- **List of Safety Standard Approved Products** →Page G-14
- The EMC value changes according to the wiring and layout. Therefore, the final EMC level must be checked with the Brake Pack incorporated in the user's equipment.

Applicable Products

K Series 1 W	Induction Motors Reversible Motors
World K Series 6 W~90 W	Induction Motors Reversible Motors Electromagnetic Brake Motors
V Series 6 W~90 W	Induction Motors Reversible Motors Electromagnetic Brake Motors
FPW Series 25 W~90 W	Induction Motors

Braking Current

When a motor is stopped suddenly, a large half-wave rectified current flows through the motor for 0.2 to 0.4 seconds. When connecting a circuit breaker, fuse or transformer, refer to the table below for the braking current (peak value) and select its current capacity.

Motor Output Power	Braking Current [A] (Peak Value)	
	110/115 VAC	220/230 VAC
1 W	1.0	—
6 W	1.5	1.0
15 W	4.5	2.5
25 W	7.5	3.5
40 W	12	7.0
60 W	18	8.5
90 W	26	12

Dimensions Scale 1/4, Unit = inch (mm)

SB50

Weight: 0.22 lb. (0.1 kg)

CAD A092

● Flush Mounting Socket
(Included with brake pack)

● Flush Mounting Socket
Panel Cut-Out

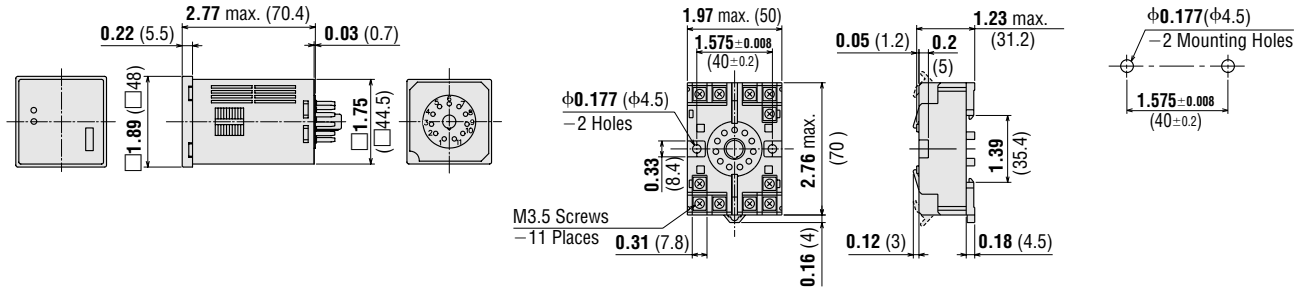

Braking Characteristics (Reference Values)

● V Series, World K Series, K Series

Induction Motors: 1 W(1/750 HP)

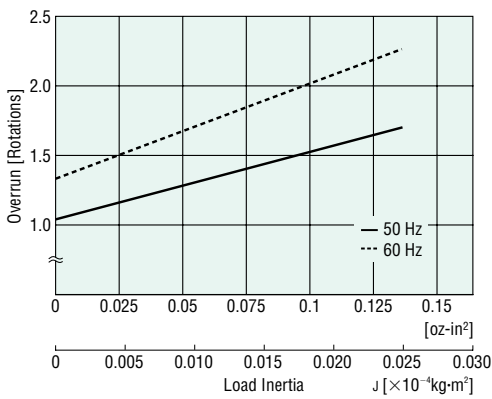

Induction Motors: 6 W(1/125 HP)

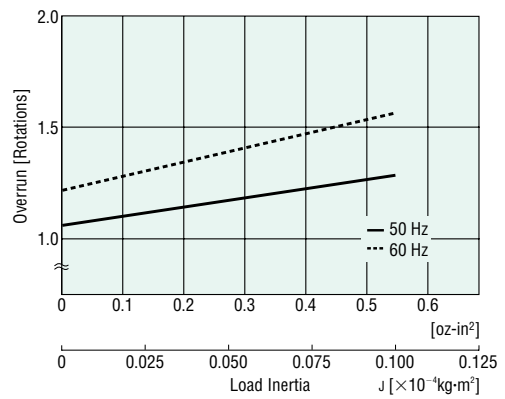

Induction Motors: 15 W(1/50 HP)

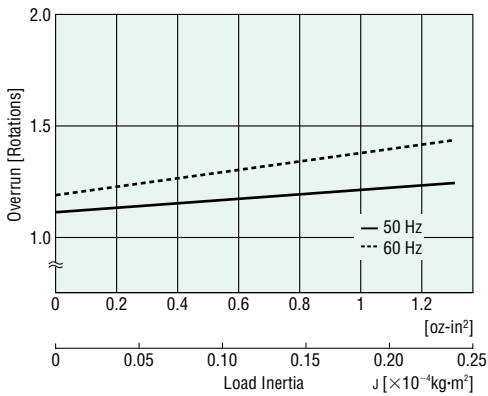

Induction Motors: 25 W(1/30 HP)

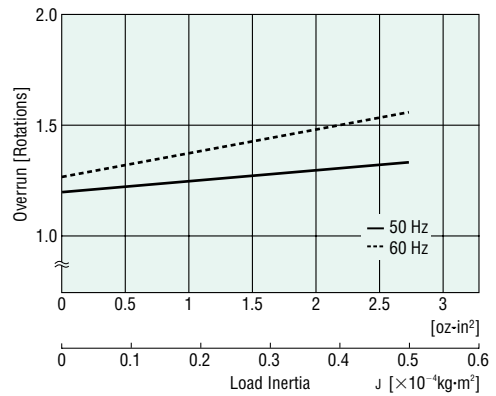

Induction Motors: 40 W(1/19 HP)

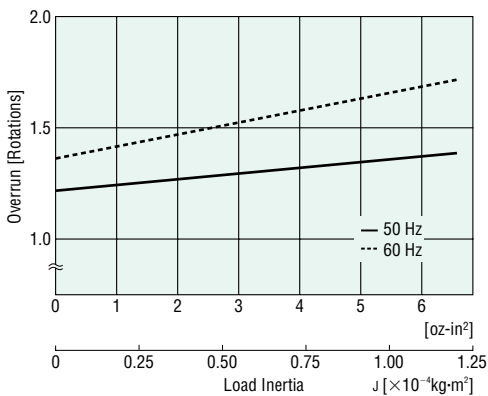

Induction Motors: 60 W(1/12 HP)

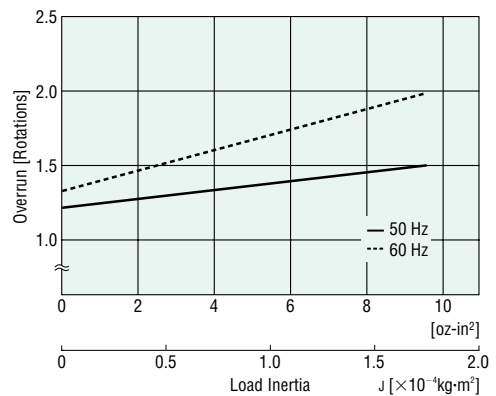

● V Series, World K Series, K Series

Induction Motors: 90 W(1/8 HP)

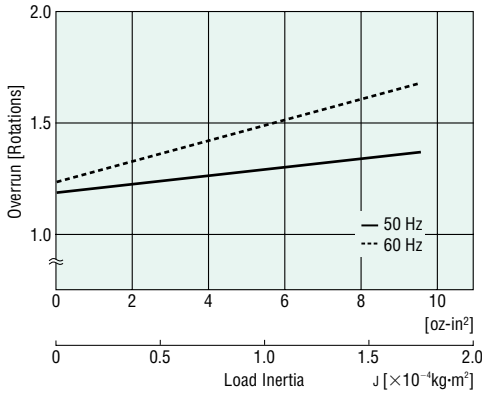

Reversible Motors: 1 W(1/750 HP)

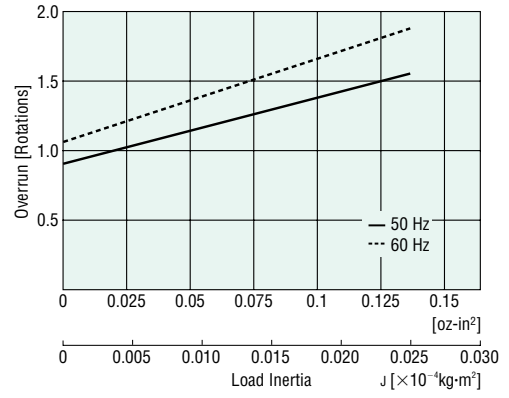

Reversible Motors: 6 W(1/125 HP)

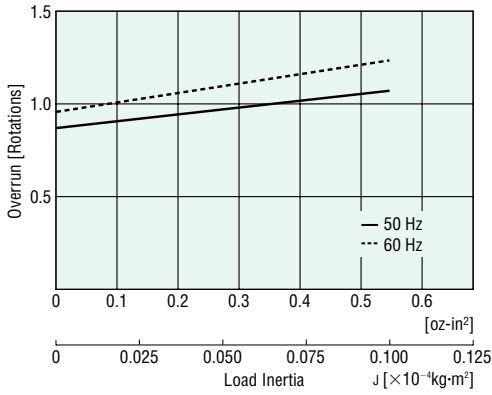

Reversible Motors: 15 W(1/50 HP)

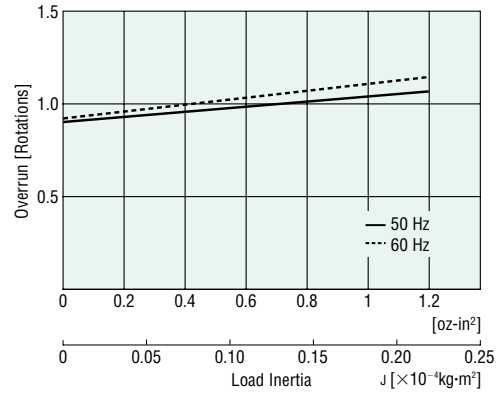

Reversible Motors: 25 W(1/30 HP)

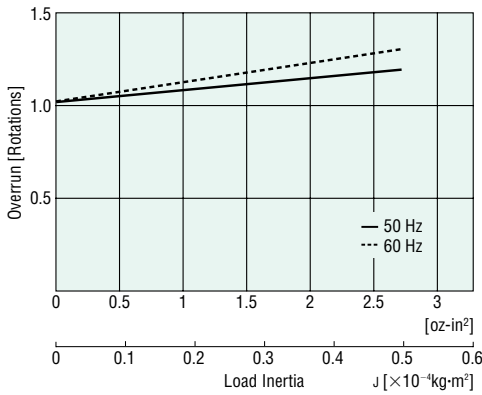

Reversible Motors: 40 W(1/19 HP)

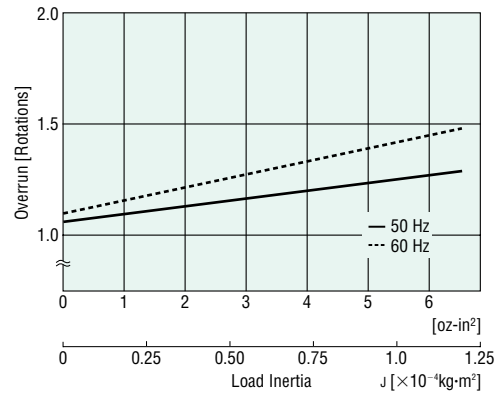

Reversible Motors: 60 W(1/12 HP)

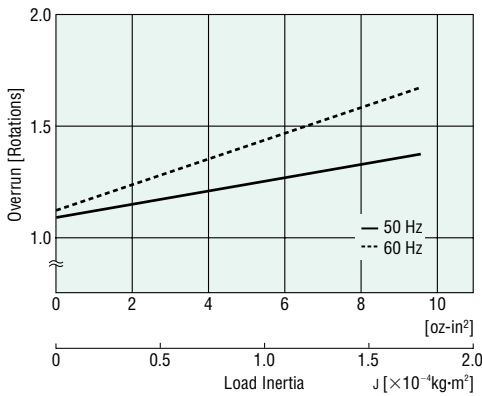

Electromagnetic Brake Motors: 90 W(1/8 HP)

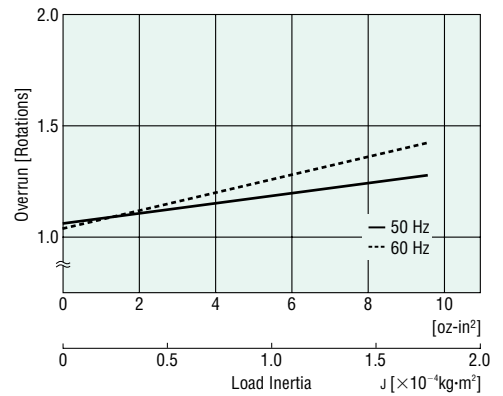

● **V Series, World K Series**

Electromagnetic Brake Motors: 6 W(1/125 HP)

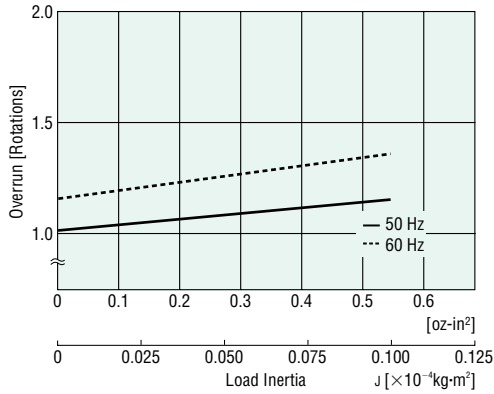

Electromagnetic Brake Motors: 15 W(1/50 HP)

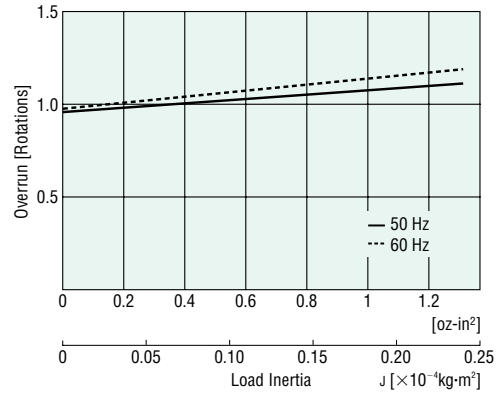

Electromagnetic Brake Motors: 25 W(1/30 HP)

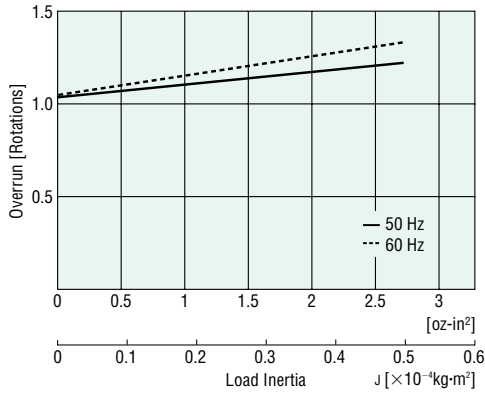

Electromagnetic Brake Motors: 40 W(1/19 HP)

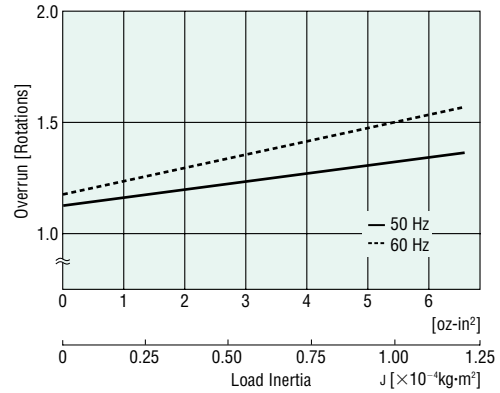

Electromagnetic Brake Motors: 60 W(1/12 HP)

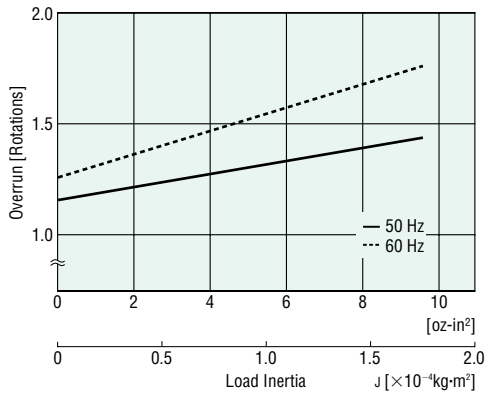

Electromagnetic Brake Motors: 90 W(1/8 HP)

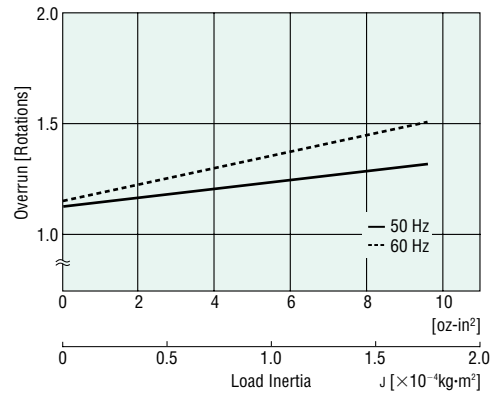

● **FPW Series (Watertight Motors)**

Watertight Motors: 25 W(1/30 HP)

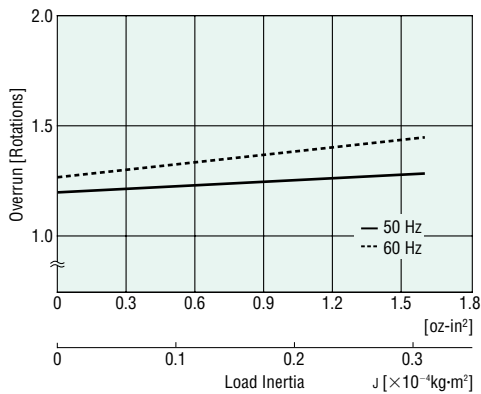

Watertight Motors: 40 W(1/19 HP)

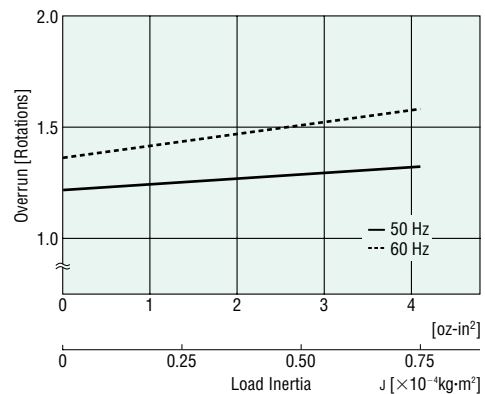

Watertight Motors: 60 W(1/12 HP)

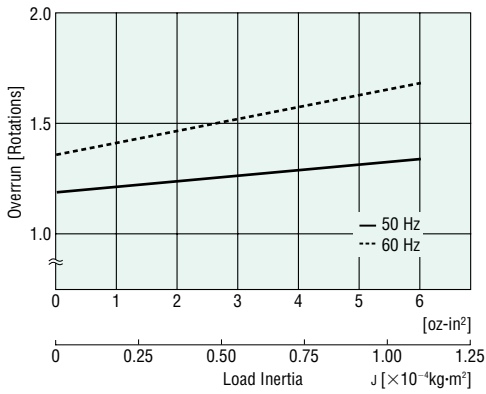

Watertight Motors: 90 W(1/8 HP)

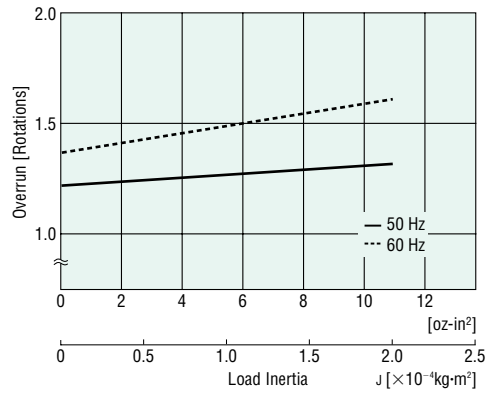

Connection and Operation

POWER Indicator (Green)
Lit when 24 VDC is supplied

ALARM Indicator (Red)
Lit when the ALARM output is "OFF"

1-40W	Set the switch to "1-40 W" when the brake pack is connected to a 1 W-40 W motor.
60-90W	Set the switch to "60-90 W" when the brake pack is connected to a 60 W-90 W motor.

*Factory setting: 60-90 W
The white square section of the switch represents the switch lever position.

Connection Diagrams

V Series, World K Series, K Series

Induction Motors (except 1W), Reversible Motors

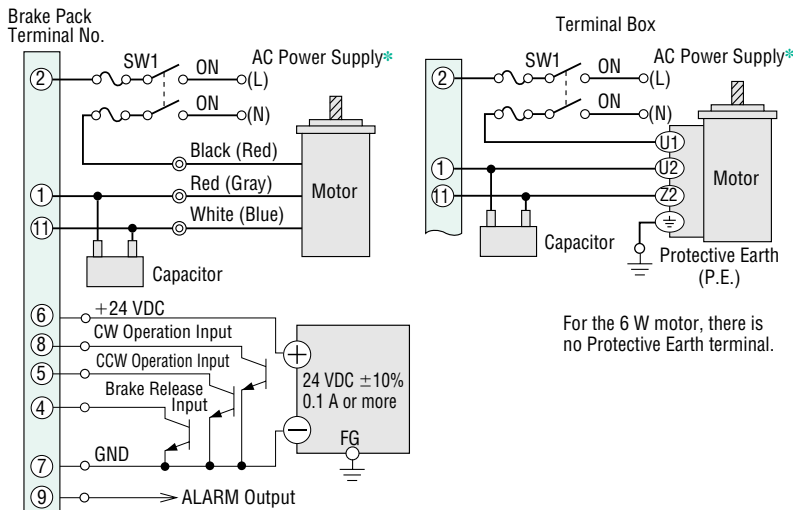

* Single-Phase 110/115 VAC
Single-Phase 220/230 VAC

Colors in parentheses () are for the lead wires of the reversible 1 W motor.

Contact Capacity of SW1

Single-phase 100-115 VAC: 125 VAC 5 A or more (Inductive load)
Single-phase 200-230 VAC: 250 VAC 5 A or more (Inductive load)

Electromagnetic Motors

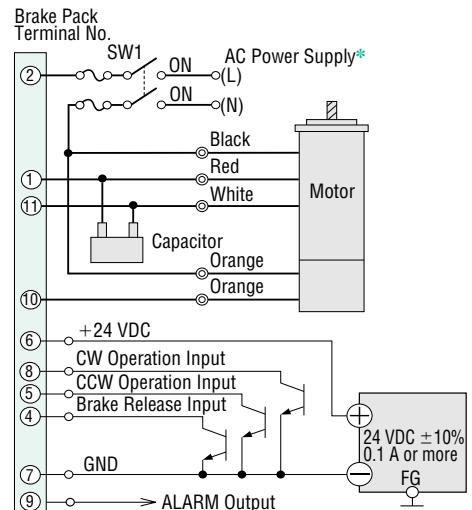

* Single-Phase 110/115 VAC
Single-Phase 220/230 VAC

◆ K Series

Induction Motors 1 W Type (OIK1GN-AUL, OIK1A-AUL)

CCW operation input is not used.

Clockwise Operation

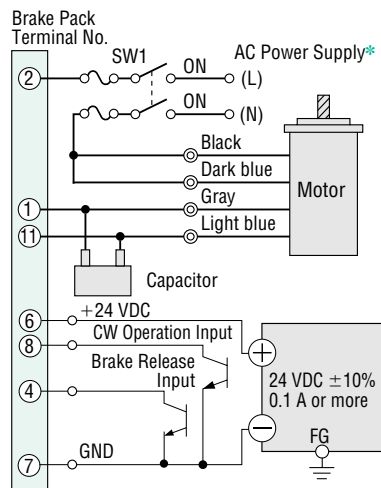

* Single-Phase 110/115 VAC

Counterclockwise Operation

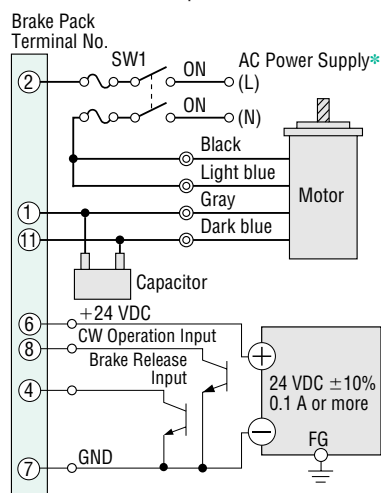

* Single-Phase 110/115 VAC

◆ FPW Series

Induction Motors

Brake Pack Terminal No.

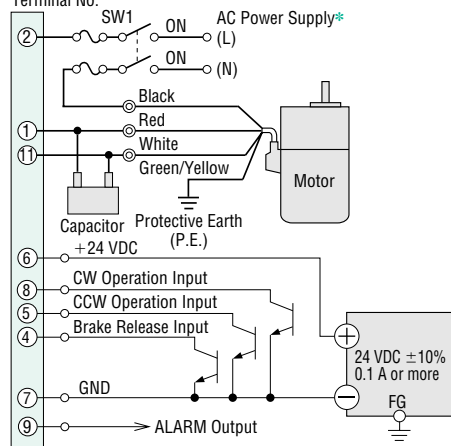

* Single-Phase 110/115 VAC
* Single-Phase 220/230 VAC

● Contact Capacity of SW1

Single-phase 100-115 VAC: 125 VAC 5 A or more (Inductive load)
Single-phase 200-230 VAC: 250 VAC 5 A or more (Inductive load)

Terminal No.	Signal Name	Description
1	Motor/Capacitor	Connect the motor and capacitor.
2	AC Power Input (L)	Single-phase 100/115 VAC or single-phase 200/230 VAC
3	NC	Not used. Leave this terminal unconnected.
4	Brake Release Input*1	Not an instantaneous stop but a natural stop during "Photocoupler ON."
5	CCW Operation Input*2	Motor runs in the CCW direction during "ON."
6	DC Power Input	+24 VDC input
7	GND	GND
8	CW Operation Input	Motor runs in the CW direction during "Photocoupler ON."
9	ALARM Output*3	Turn open-collector output "OFF" when the motor's thermal protector is "open."
10	Electromagnetic Brake*4	Connect to the electromagnetic brake.
11	Motor/Capacitor	Connect the motor and capacitor.

*1 Releases the electromagnetic brake for electromagnetic brake motors.

*2 Not used with an induction motor with four lead wires.

*3 Only for motors with a built-in thermal protector.

*4 Only for electromagnetic brake motors.

Notes:

- The input-signal voltage is 24 VDC \pm 10% and 0.1 A or more.
- Minimize the length of the motor cable and the input/output signal cable to reduce EMI.
- Use a cable of AWG 18 or more in diameter for the motor cable and power cable.
- Be sure to connect the GND terminal to GND (negative side) of the external controller, or the unit will not operate.

● I/O Signal Circuit

◆ Input Circuit (Internal Circuit)

The input-signal voltage is 24 VDC \pm 10%.

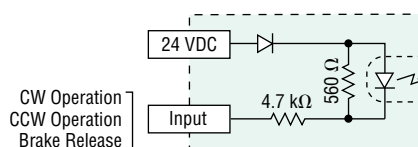

◆ Output Circuit (Internal Circuit)

Output signals are open-collector outputs. Use a power source of 26.4 VDC or less, and limit the output current to 10 mA or less.

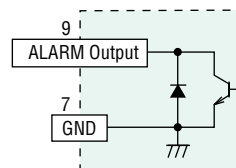

Introduction

Induction Motors

Reversible Motors

Synchronous Motors

Torque Motors

Water-tight Motors

Magnetic Brake

Clutch & Brake

Brake Pack

Right-Angle Gearheads

Accessories

Before Using a Standard AC Motor

● Timing Chart

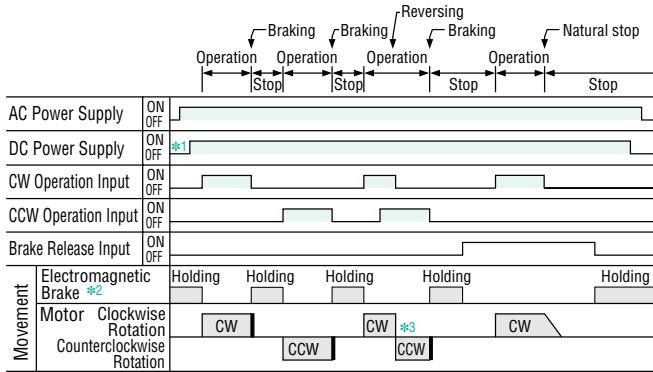

- *1 Turn on DC power after turning on AC power. The motor does not operate if DC power is input ahead of AC power. The ALARM indicator will light and ALARM output will switch to "OFF."
- *2 Only for motors with electromagnetic brakes.
- *3 The induction motor will not accommodate instantaneous forward/reverse switching. Change the direction of motor rotation only after bringing the motor to a stop.

◆ CW Operation Input

Turning the CW operation signal to "Photocoupler ON" causes the motor's output shaft to turn in the CW direction. Turning it to "Photocoupler OFF" triggers an instantaneous stop.

◆ CCW Operation Input

Turning the CCW operation signal to "Photocoupler ON" causes the motor's output shaft to turn in the CCW direction. Turning it to "Photocoupler OFF" triggers an instantaneous stop.

If both the CW and CCW operation signals are simultaneously turned to "Photocoupler ON," the CW operation signal will take priority. Therefore, the wiring must be changed with an induction motor having four lead wires.

◆ Brake Release Input

Turning the brake release signal to "Photocoupler ON" disables both the electronic brake and electromagnetic brake. When the CW and CCW operation signals are turned to "Photocoupler OFF," the motor operates via inertial force before coming to a natural stop. When the motor is stationary, the electromagnetic brake does not operate, so the motor's output shaft can be moved freely.

Turning the brake release signal to "Photocoupler OFF" (or leaving the signal unconnected) and turning the CW and CCW operation signals to "Photocoupler OFF" will activate the electronic brake and electromagnetic brake, bringing the motor to an instantaneous stop. Once the motor stops, the electronic brake will release automatically. However, the electromagnetic brake will continue to operate and hold the load.

● Thermal-Protector Open Detection

If the built-in thermal protector is triggered to "open" during operation, the brake pack will turn the ALARM output to "OFF" and light the ALARM indicator lamp (red) on the panel (while the motor stops as the power goes off).

With electromagnetic brake motors, the brake is activated in order to hold the load in position.

In the case of a motor which does not have a built-in thermal protector, the ALARM output will not be turned to "OFF."

When ALARM output is turned to "OFF," turn all power off and set input signals to "OFF."

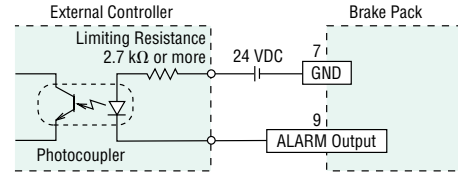

Use a power source of 26.4 VDC or less, and limit the output current to 10 mA or less.

● Operating/Braking Repetition Cycle

The repeated operation and braking of a motor will cause about a temperature increase in the motor and brake pack, thereby limiting the continuous operating time. Observe the repetition cycle given in the table below for the operation and braking of the motor. The motor may generate heat depending on the conditions in which it is driven. Ensure that the temperature of the motor case does not exceed 194°F (90°C).

Motor Output	Repetition Cycle
1 W~25 W	2 seconds or more
40 W~90 W	4 seconds or more

(A repetition cycle of two seconds represents operation for one second and stopping for one second.)